

MF BATTERY

MF | MAINTENANCE FREE

REF BTX14-BS



12V VOLTAGE - V

200A CCA - A

12.6Ah VOLTAGE - Ah (20Hr)

12Ah VOLTAGE - Ah (10Hr)

TECHNOLOGY

- AGM construction (absorbed acid)
- VRLA battery (Valve Regulated Lead Acid)
- Supplied with a separate acid pack
- Homologated by OEM

FEATURES

- Upright installation only
- Maintenance free (no water refilling)
- Sealed after filling, no gas emission through venting hole (under normal operation)
- High power
- Does not need to be recharged while stocked
- Suitable for cold weather
- Reduction of plate sulfation
- Higher life cycle (up to three times longer than conventional batteries)
- Longer voltage hold

UPGRADE FOR

WEIGHT

Battery (with acid) : Approx 4.37kg (9.63lbs)

MOUNTING ANGLE

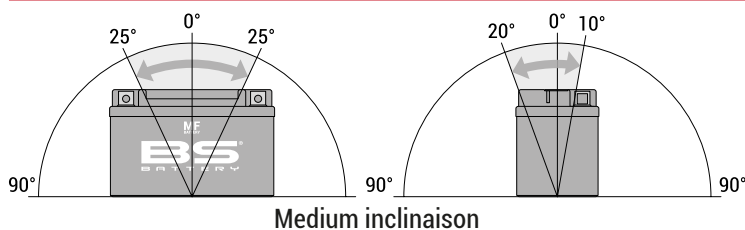

DIMENSIONS

Length (A) : 150±2mm (5.91in)
 Width (B) : 87±2mm (3.43in)
 Container height : 145±2mm (5.71in)
 Total height (C) : 145±2mm (5.71in)

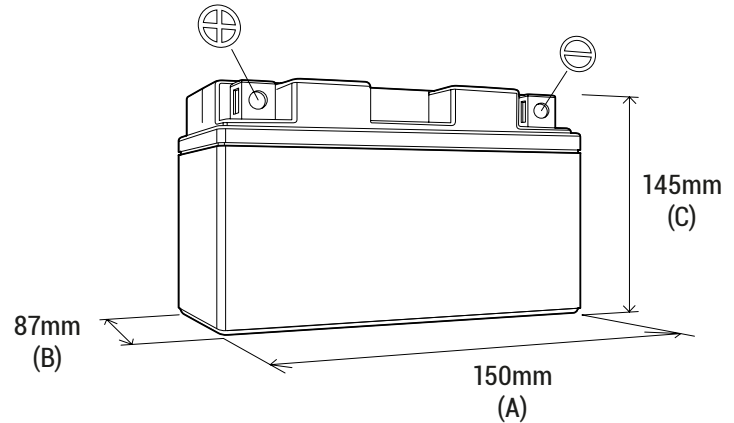

TERMINALS

